



ETA-Danmark A/S
Kollegievej 6
DK-2920 Charlottenlund
Tel. +45 72 24 59 00
Fax +45 72 24 59 04
Internet www.etadanmark.dk

Authorised and notified according
to Article 29 of the Regulation (EU)
No 305/2011 of the European
Parliament and of the Council of 9
March 2011

MEMBER OF EOTA



European Technical Assessment ETA-09/0133 of 2014-05-23

I General Part

Technical Assessment Body issuing the ETA and designated according to Article 29 of the Regulation (EU) No 305/2011: ETA-Danmark A/S

Trade name of the construction product:

Gutzeit Angle Brackets type 89521, 89525, 89530, 89532, 89533, 89560, 89561, 89562, 89571, 89572, 89573, 89574, 89575, 89576, 89577, 89578, 89579, 89580, 89581, 89582, 89583, 89584, 89585, 89586, 89587, 89588, 89589, 89600, 89601, 89602

Product family to which the above construction product belongs:

Three-dimensional nailing plate (Angle Bracket for timber-to-timber or timber to steel or concrete connections)

Manufacturer:

Gutzeit Verbindungssysteme GmbH & Co.
Rudolf-Diesel-Strasse 1
D-58730 Fröndenberg, Industriegebiet
Tel. +49 2373 - 979261
Fax +49 2373 - 979266
Internet www.gutzeit-holzverbinder.de

Manufacturing plant:

Gutzeit Verbindungssysteme GmbH & Co.
Rudolf-Diesel-Strasse 1
D-58730 Fröndenberg, Industriegebiet

This European Technical Assessment contains:

23 pages including 2 annexes which form an integral part of the document

This European Technical Assessment is issued in accordance with Regulation (EU) No 305/2011, on the basis of:

Guideline for European Technical Approval (ETAG) No. 015 Three Dimensional Nailing Plates, April 2013, used as European Assessment Document (EAD).

This version replaces:

The previous ETA with the same number issued on 2009-06-03 and expiry on 2014-06-03

Translations of this European Technical Assessment in other languages shall fully correspond to the original issued document and should be identified as such.

Communication of this European Technical Assessment, including transmission by electronic means, shall be in full (excepted the confidential Annex(es) referred to above). However, partial reproduction may be made, with the written consent of the issuing Technical Assessment Body. Any partial reproduction has to be identified as such.

II SPECIFIC PART OF THE EUROPEAN TECHNICAL ASSESSMENT

1 Technical description of product and intended use

Technical description of the product

Gutzeit angle brackets are one-piece non-welded, face-fixed angle brackets to be used in timber to timber or in timber to concrete or to steel connections. They are connected to construction members made of timber or wood-based products with profiled (ringed shank) nails according to EN 14592 and to concrete or steel members with bolts or metal anchors.

The angle brackets are made from pre-galvanized steel DX 51 D / Z 275 according to EN 10346:2009 with $R_e \geq 295 \text{ N/mm}^2$, $R_m \leq 360 \text{ N/mm}^2$ and $A_{80} \geq 22\%$. Dimensions, hole positions and typical installations are shown in Annex A. Gutzeit angle brackets are made from steel with tolerances according to EN 10143.

2 Specification of the intended use in accordance with the applicable EAD

The angle brackets are intended for use in making connections in load bearing timber structures, as a connection between a beam and a purlin, where requirements for mechanical resistance and stability and safety in use in the sense of the Basic Works Requirements 1 and 4 of Regulation (EU) 305/2011 shall be fulfilled.

The connection may be with a single angle bracket or with an angle bracket on each side of the fastened timber member (see Annex A).

The static and kinematical behaviour of the timber members or the supports shall be as described in Annex B.

The wood members may be of solid timber, glued laminated timber and similar glued members, or wood-based structural members with a characteristic density from 290 kg/m^3 to 420 kg/m^3 . This requirement to the material of the wood members can be fulfilled by using the following materials:

- Structural solid timber classified to C14-C40 according to EN 338 / EN 14081,
- Glulam classified to GL24-GL36 according to EN 1194 / EN 14080,
- LVL according to EN 14374,
- Parallam PSL,

- Intrallam LSL,
- Duo- and Triobalken,
- Layered wood plates,
- Plywood according to EN 636

Annex B states the load-carrying capacities of the angle bracket connections for a characteristic density of 350 kg/m^3 . For timber or wood based material with a lower characteristic density than 350 kg/m^3 the load-carrying capacities shall be reduced by the k_{dens} factor:

$$k_{\text{dens}} = \left(\frac{\rho_k}{350} \right)^2$$

Where ρ_k is the characteristic density of the timber in kg/m^3 .

The design of the connections shall be in accordance with Eurocode 5 or a similar national Timber Code. The wood members shall have a thickness which is larger than the penetration depth of the nails into the members.

The angle brackets are primarily for use in timber structures subject to the dry, internal conditions defined by service classes 1 and 2 of Eurocode 5 and for connections subject to static or quasi-static loading.

The angle brackets can also be used in outdoor timber structures, service class 3, when a corrosion protection in accordance with Eurocode 5 is applied, or when stainless steel with similar or better characteristic yield and ultimate strength is employed.

Some of the angle brackets may also be used for connections between a timber member and a member of concrete or steel.

The scope of the brackets regarding resistance to corrosion shall be defined according to national provisions that apply at the installation site considering environmental conditions.

The provisions made in this European Technical Assessment are based on an assumed intended working life of the angle brackets of 50 years.

The indications given on the working life cannot be interpreted as a guarantee given by the producer or Assessment Body, but are to be regarded only as a means for choosing the right products in relation to the expected economically reasonable working life of the works.

3 Performance of the product and references to the methods used for its assessment

Characteristic	Assessment of characteristic
3.1 Mechanical resistance and stability*) (BWR1)	
Characteristic load-carrying capacity	See Annex B
Stiffness	No performance determined
Ductility in cyclic testing	No performance determined
3.2 Safety in case of fire (BWR2)	
Reaction to fire	The angle brackets are made from steel classified as Euroclass A1 in accordance with EN 1350-1 and EC decision 96/603/EC, amended by EC Decision 2000/605/EC
3.3 Hygiene, health and the environment (BWR3)	
Influence on air quality	No dangerous materials**)
3.7 Sustainable use of natural resources (BWR7)	
3.8 General aspects related to the performance of the product	The angle brackets have been assessed as having satisfactory durability and serviceability when used in timber structures using the timber species described in Eurocode 5 and subject to the conditions defined by service class 1 and 2
Identification	See Annex A

*) See additional information in section 3.8 – 3.9.

**) In addition to the specific clauses relating to dangerous substances contained in this European technical Assessment, there may be other requirements applicable to the products falling within its scope (e.g. transposed European legislation and national laws, regulations and administrative provisions). In order to meet the provisions of the Construction Products Regulation, these requirements need also to be complied with, when and where they apply.

3.9 Methods of verification

The characteristic load-carrying capacities are based on the characteristic values of the nail connections, the timber components and the steel plates. To obtain design values the capacities have to be divided by different partial factors for the material properties, the nail connection and the timber components in addition multiplied with the coefficient k_{mod} .

According to EN 1990 (Eurocode – Basis of design) paragraph 6.3.5 the design value of load-carrying capacity can be determined by reducing the characteristic values of the load-carrying capacity with different partial factors.

Thus, the characteristic values of the load-carrying capacity are determined also for timber failure $F_{\text{Rk},\text{N}}$ (reaching the embedment strength of nails subjected to shear), $F_{90,\text{Rk}}$ (reaching the transverse tensile strength of the timber components) as well as for steel plate failure $F_{\text{Rk},\text{S}}$. The design value of the load-carrying capacity is the smaller value of both load-carrying capacities.

$$F_{\text{Rd}} = \min \left\{ \frac{k_{\text{mod}} \cdot F_{\text{Rk},\text{N}}}{\gamma_{\text{M},\text{H}}}; \frac{F_{\text{Rk},\text{S}}}{\gamma_{\text{M},\text{S}}}; \frac{k_{\text{mod}} \cdot F_{90,\text{Rk}}}{\gamma_{\text{M},\text{H}}} \right\}$$

Therefore, for timber failure and the nails connection the load duration class and the service class are included. The different partial factors γ_{M} for steel or timber, respectively, are also correctly taken into account.

3.10 Mechanical resistance and stability

See annex B for the characteristic load-carrying capacity in the different directions F_1 to F_5 .

The characteristic capacities of the angle brackets are determined by calculation assisted by testing as described in the EOTA Guideline 015 clause 5.1.2. They should be used for designs in accordance with Eurocode 5 or a similar national Timber Code.

Threaded nails (ringed shank nails) in accordance to EN 14592

In the formulas in Annex B the capacities for threaded nails calculated from the formulas of Eurocode 5 are used assuming a thick steel plate when calculating the lateral nail load-carrying-capacity.

The load bearing capacities of the brackets has been determined based on the use of connector nails 4,0 x 40 mm in accordance with the German national approval for the nails.

The characteristic withdrawal capacity of the nails has to be determined by calculation in accordance with EN 1995-1-1: 2004, paragraph 8.3.2 (head pull-through is not relevant):

$$F_{\text{ax},\text{Rk}} = f_{\text{ax},\text{k}} \times d \times t_{\text{pen}}$$

Where:

$f_{\text{ax},\text{k}}$ Characteristic value of the withdrawal parameter in N/mm²
 d Nail diameter in mm
 t_{pen} Penetration depth of the profiled shank including the nail point in mm, $t_{\text{pen}} \geq 31$ mm

Based on tests by Versuchsanstalt für Stahl, Holz und Steine, University of Karlsruhe, the characteristic value of the withdrawal resistance for the threaded nails used can be calculated as:

$$f_{\text{ax},\text{k}} = 50 \times 10^{-6} \times \sigma_{\text{k}}^2$$

Where:

σ_{k} Characteristic density of the timber in kg/m³

The shape of the nail directly under the head shall be in the form of a truncated cone with a diameter under the nail head which exceeds the hole diameter.

The design models allow the use of fasteners described in the table on page 10 in Annex A

No performance has been determined in relation to ductility of a joint under cyclic testing. The contribution to the performance of structures in seismic zones, therefore, has not been assessed.

No performance has been determined in relation to the joint's stiffness properties - to be used for the analysis of the serviceability limit state.

3.11 Aspects related to the performance of the product

3.11.1 Corrosion protection in service class 1 and 2.

The purlin ties are made from pre-galvanized steel DX 51 D / Z 275 according to EN 10346:2009 with $R_e \geq 295$ N/mm², $R_m \leq 360$ N/mm² and $A_{80} \geq 22\%$

3.12 General aspects related to the fitness for use of the product

Gutzeit angle brackets are manufactured in accordance with the provisions of this European Technical Assessment using the manufacturing processes as identified in the inspection of the plant by the notified inspection body and laid down in the technical documentation

The nailing pattern used shall be either the maximum or the minimum pattern as defined in Annex A.

The following provisions concerning installation apply:

The structural members – the components 1 and 2 shown in the figure on page 18 - to which the brackets are fixed shall be:

- Restrained against rotation. At a load F_4/F_5 , the component 2 is allowed to be restrained against rotation by the Angle brackets.
- Strength class C14 or better, see section 1 of this ETA
- Free from wane under the bracket.
- The actual end bearing capacity of the timber member to be used in conjunction with the bracket is checked by the designer of the structure to ensure it is not less than the bracket capacity and, if necessary, the bracket capacity reduced accordingly.
- The gap between the timber members does not exceed 3 mm.
- There are no specific requirements relating to preparation of the timber members.
- The execution of the connection shall be in accordance with the approval holder's technical literature.

4 Attestation and verification of constancy of performance (AVCP)

4.1 AVCP system

According to the decision 97/638/EC of the European Commission¹, as amended, the system(s) of assessment and verification of constancy of performance (see Annex V to Regulation (EU) No 305/2011) is 2+.

5 Technical details necessary for the implementation of the AVCP system, as foreseen in the applicable EAD

Technical details necessary for the implementation of the AVCP system are laid down in the control plan deposited at ETA-Danmark

Issued in Charlottenlund on 2014-05-23 by

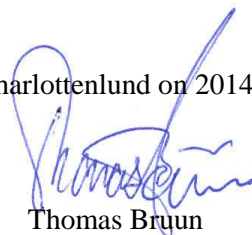

Thomas Bruun
Managing Director, ETA-Danmark

Annex A
Product details definitions

Table A.1 Materials specification

Bracket number	Bracket type	Thickness (mm)	Steel specification	Coating specification
89 521	50x50x35	2,5	DX 51 D	Z 275
89 525	90x90x40	3,0	DX 51 D	Z 275
89 530	160x40x40	3,0	DX 51 D	Z 275
89 532	120x35x40	3,0	DX 51 D	Z 275
89 533	90x35x40	2,5	DX 51 D	Z 275
89 560	90x48x48	3,0	DX 51 D	Z 275
89 561	90x48x76	3,0	DX 51 D	Z 275
89 562	90x48x116	3,0	DX 51 D	Z 275
89 571	40x40x40	2,0	DX 51 D	Z 275
89 572	50x50x40	2,0	DX 51 D	Z 275
89 573	60x60x40	2,0	DX 51 D	Z 275
89 574	60x60x50	2,5	DX 51 D	Z 275
89 575	60x60x60	2,0	DX 51 D	Z 275
89 576	40x40x60	2,5	DX 51 D	Z 275
89 577	60x60x80	2,5	DX 51 D	Z 275
89 578	60x60x100	2,5	DX 51 D	Z 275
89 579	80x80x60	2,5	DX 51 D	Z 275
89 580	80x80x80	2,5	DX 51 D	Z 275
89 581	80x80x100	2,5	DX 51 D	Z 275
89 582	100x100x60	2,5	DX 51 D	Z 275
89 583	100x100x80	2,5	DX 51 D	Z 275
89 584	100x100x100	2,5	DX 51 D	Z 275
89 585	40x40x100	2,0	DX 51 D	Z 275
89 586	40x40x140	2,0	DX 51 D	Z 275
89 587	40x40x200	2,0	DX 51 D	Z 275
89 588	60x60x40	2,5	DX 51 D	Z 275
89 589	60x60x60	2,5	DX 51 D	Z 275
89 600	60x40x60	2,5	DX 51 D	Z 275
89 601	80x60x60	2,5	DX 51 D	Z 275
89 602	100x60x60	2,5	DX 51 D	Z 275

Table A.2 Range of sizes

Bracket number	Bracket type	Height (mm)		Height (mm)		Width (mm)	
		vertical		horizontal			
89 521	50x50x35	49	51	49	51	34	36
89 525	90x90x40	89	91	89	91	39	41
89 530	160x40x40	159	161	39	41	39	42
89 532	120x35x40	119	121	34	36	39	41
89 533	90x35x40	89	91	34	36	39	41
89 560	90x48x48	89	91	47	49	47	49
89 561	90x48x76	89	91	47	49	75	77
89 562	90x48x116	89	91	47	49	115	117
89 571	40x40x40	39	41	39	41	39	41
89 572	50x50x40	49	51	49	51	44	46
89 573	60x60x40	59	61	59	61	39	41
89 574	60x60x50	59	61	59	61	49	51
89 575	60x60x60	59	61	59	61	59	61
89 576	40x40x60	39	41	39	41	59	61
89 577	60x60x80	59	61	59	61	79	81
89 578	60x60x100	59	61	59	61	99	101
89 579	80x80x60	79	81	79	81	59	61
89 580	80x80x80	79	81	79	81	79	81
89 581	80x80x100	79	81	79	81	99	101
89 582	100x100x60	99	101	99	101	59	61
89 583	100x100x80	99	101	99	101	79	81
89 584	100x100x100	99	101	99	101	99	101
89 585	40x40x100	39	41	39	41	99	101
89 586	40x40x140	39	41	39	41	139	141
89 587	40x40x200	39	41	39	41	199	201
89 588	60x60x40	59	61	59	61	39	41
89 589	60x60x60	59	61	59	61	59	61
89 600	60x40x60	59	61	39	41	59	61
89 601	80x60x60	79	81	59	61	59	61
89 602	100x60x60	99	101	59	61	59	61

Table A.3 Fastener specification

Nail type	Nail size (mm)		Finish
	Diameter	Length	
According to EN 14592			
Threaded nail	4,0	40	Electroplated zinc

In the load-carrying-capacities of the nailed connection in Annex B the capacities for threaded nails calculated from the formulas of Eurocode 5 are used assuming a thick steel plate when calculating the lateral nail load-carrying-capacity.

The load-carrying-capacities of the angle brackets have been determined based on the use of connector nails 4,0 x 40 mm in accordance with the German national approval for the nails.

The characteristic withdrawal capacity of the nails has to be determined by calculation in accordance with EN 1995-1-1:2004, paragraph 8.3.2 (head pull-through is not relevant):

$$F_{ax,Rk} = f_{ax,k} \times d \times t_{pen}$$

Where:

$f_{ax,k}$ Characteristic value of the withdrawal parameter in N/mm^2

d Nail diameter in mm

t_{pen} Penetration depth of the profiled shank including the nail point in mm, $t_{pen} \geq 31$ mm

Based on tests by Versuchsanstalt für Stahl, Holz und Steine, University of Karlsruhe, the characteristic value of the withdrawal resistance for the threaded nails used can be calculated as:

$$f_{ax,k} = 50 \times 10^{-6} \times \rho_k^2$$

Where:

ρ_k Characteristic density of the timber in kg/m^3

The shape of the nail directly under the head shall be in the form of a truncated cone with a diameter under the nail head which exceeds the hole diameter.

BOLTS diameter	Correspondence Hole diameter	Bolts type
12.0	Max. 2 mm. larger than the bolt diameter	See specification of the manufacturer

METAL ANCHORS diameter	Correspondence Hole diameter	Anchors type
12.0	Max. 2 mm. larger than the anchor diameter	See specification of the manufacturer

The load-carrying-capacities of the angle bracket 89532 have been determined based on the use of metal anchors with a diameter of 12 mm according to an ETA and with a minimum load-carrying capacity in tension and shear of 5 kN.

Annex B
Characteristic load-carrying capacities

Table B.1: Force F_1 Column, 2 angle brackets / connection

Bracket number	Bracket type	Nail number n_v	Nail number n_H	$F_{1,Rk}$ [kN] (column)	
				Timber	Steel
89 525	90x90x40	1,2	11,12,14,15,19,20	2,38	2,15
89 530	160x40x40	1,2,3,4,6,7	15,16,18,19	1,95	3,19
89 532	120x35x40	1,2,3,4,5,6	Bolt/Metal anchor	3,33	1,79
89 533	90x35x40	1,2,3	8,9,11,12	1,92	2,51
89 560	90x48x48	1,2,4	10,11,13,14	2,01	3,48
89 561	90x48x76	1,2,3,6	16,17,20,21	2,01	6,04
89 562	90x48x116	1,2,3,4,5,8,9	22,23,24,25,29,30,31	4,03	8,79
89 579	80x80x60	31,32,33	fully nailed	3,95	4,15
89 580	80x80x80	31,32,33,34	fully nailed	5,27	5,53
89 581	80x80x100	31,32,33,34,35	fully nailed	6,58	6,91
89 582	100x100x60	31,32,33,41,42,43	fully nailed	4,08	4,15
89 583	100x100x80	31,32,33,34,41,42,43,44	fully nailed	5,44	5,53
89 584	100x100x100	31,32,33,34,35,41,42,43,44,45	fully nailed	6,80	6,91
89 601	80x60x60	31,32,33	fully nailed	3,73	4,15
89 602	100x60x60	31,32,33,41,42,43	fully nailed	3,73	4,15

Table B.2: Force F_1 Column, 1 angle bracket / connection

Bracket number	Bracket type	Nail number n_V	Nail number n_H	$F_{1,Rk}$ [kN] (column)	
				Timber	Steel
89 525	90x90x40	1,2	11,12,14,15,19,20	1,19	1,08
89 530	160x40x40	1,2,3,4,6,7	15,16,18,19	0,98	1,59
89 532	120x35x40	1,2,3,4,5,6	bolt	1,67	0,90
89 533	90x35x40	1,2,3	8,9,11,12	0,96	1,26
89 560	90x48x48	1,2,4	10,11,13,14	1,01	1,74
89 561	90x48x76	1,2,3,6	16,17,20,21	1,01	3,02
89 562	90x48x116	1,2,3,4,5,8,9	22,23,24,25,29,30,31	2,01	4,39
89 579	80x80x60	31,32,33	fully nailed	1,97	2,07
89 580	80x80x80	31,32,33,34	fully nailed	2,63	2,77
89 581	80x80x100	31,32,33,34,35	fully nailed	3,29	3,46
89 582	100x100x60	31,32,33,41,42,43	fully nailed	2,04	2,07
89 583	100x100x80	31,32,33,34,41,42,43,44	fully nailed	2,72	2,77
89 584	100x100x100	31,32,33,34,35,41,42,43,44,45	fully nailed	3,40	3,46
89 601	80x60x60	31,32,33	fully nailed	1,86	2,07
89 602	100x60x60	31,32,33,41,42,43	fully nailed	1,86	2,07

Table B.3: Force F_1 Purlin, 2 angle brackets / connection

Bracket number	Bracket type	Nail number n_V	Nail number n_H	$F_{1,Rk}$ [kN] (purlin)	
				Timber	Steel
89 521	50x50x35	1,2	6,7,9,10	2,19	1,84
89 525	90x90x40	1,2,4,5,6,7	11,12,14,15,19,20	2,38	2,15
89 530	160x40x40	1,2,3,4,6,7,8,9,10,11	15,16,18,19	1,95	3,19
89 532	120x35x40	1,2,3,4,5,6,7,8,9	bolt	3,33	1,79
89 533	90x35x40	1,2,3,5,6	8,9,11,12	1,92	2,51
89 560	90x48x48	1,2,4,5,6,7	10,11,13,14	2,01	3,48
89 561	90x48x76	1,2,3,6,7,8,9,10,11,12	16,17,20,21	2,01	6,04
89 562	90x48x116	1,2,3,4,5,8,9,10,11, 12,13,15,16,17,18	22,23,24,25,29,30,31	4,03	8,79
89 571	40x40x40	11,12	fully nailed	2,17	1,77
89 572	50x50x40	11,12	fully nailed	2,36	1,77
89 573	60x60x40	11,12,21,22	fully nailed	2,49	1,77
89 574	60x60x50	11,12,13,21,22	fully nailed	3,73	3,23
89 575	60x60x60	11,12,13,21,22,23	fully nailed	3,73	2,66
89 576	40x40x60	11,12,13	fully nailed	3,26	4,15
89 577	60x60x80	11,12,13,14,21,22,23,24	fully nailed	4,97	5,53
89 578	60x60x100	11,12,13,14,15,21,22,23,24,25	fully nailed	6,21	6,91
89 579	80x80x60	11,12,13,21,22,23,31,32,33	fully nailed	3,95	4,15
89 580	80x80x80	11,12,13,14,21,22,23,24,31,32, 33,34	fully nailed	5,27	5,53
89 581	80x80x100	11,12,13,14,15,21,22,23,24,25,3 1,32,33,34,35	fully nailed	6,58	6,91
89 582	100x100x60	11,12,13,21,22,23,31,32,33,41, 42,43	fully nailed	4,08	4,15
89 583	100x100x80	11,12,13,14,21,22,23,24,31,32, 33,34,41,42,43,44	fully nailed	5,44	5,53
89 584	100x100x100	11,12,13,14,15,21,22,23,24,25, 31,32,33,34,35,41,42,43,44,45	fully nailed	6,80	6,91
89 585	40x40x100	11,12,13,14,15	fully nailed	5,43	4,43
89 586	40x40x140	11,12,13,14,15,16,17	fully nailed	7,60	6,20
89 587	40x40x200	11,12,13,14,15,16,17,18,19,20	fully nailed	10,85	8,85
89 588	60x60x40	11,12,21,22	fully nailed	2,49	2,77
89 589	60x60x60	11,12,13,21,22,23	fully nailed	3,73	4,15
89 600	60x40x60	11,12,13,21,22,23	fully nailed	3,26	4,15
89 601	80x60x60	11,12,13,21,22,23,31,32,33	fully nailed	3,73	4,15
89 602	100x60x60	11,12,13,21,22,23,31,32,33,41, 42,43	fully nailed	3,73	4,15

Table B.4: Force F_1 Purlin, 1 angle bracket / connection

Bracket number	Bracket type	Nail number n_V	Nail number n_H	$F_{1,Rk}$ [kN] (purlin)	
				Timber	Steel
89 521	50x50x35	1,2	6,7,9,10	1,10	0,92
89 525	90x90x40	1,2,4,5,6,7	11,12,14,15,19,20	1,19	1,08
89 530	160x40x40	1,2,3,4,6,7,8,9,10,11	15,16,18,19	0,98	1,59
89 532	120x35x40	1,2,3,4,5,6,7,8,9	bolt	1,67	0,90
89 533	90x35x40	1,2,3,5,6	8,9,11,12	0,96	1,26
89 560	90x48x48	1,2,4,5,6,7	10,11,13,14	1,01	1,74
89 561	90x48x76	1,2,3,6,7,8,9,10,11,12	16,17,20,21	1,01	3,02
89 562	90x48x116	1,2,3,4,5,8,9,10,11,12,13,15,16,17,18	22,23,24,25,29,30,31	2,01	4,39
89 571	40x40x40	11,12	fully nailed	1,09	0,89
89 572	50x50x40	11,12	fully nailed	1,18	0,89
89 573	60x60x40	11,12,21,22	fully nailed	1,24	0,89
89 574	60x60x50	11,12,13,21,22	fully nailed	1,86	1,61
89 575	60x60x60	11,12,13,21,22,23	fully nailed	1,86	1,33
89 576	40x40x60	11,12,13	fully nailed	1,63	2,07
89 577	60x60x80	11,12,13,14,21,22,23,24	fully nailed	2,49	2,77
89 578	60x60x100	11,12,13,14,15,21,22,23,24,25	fully nailed	3,11	3,46
89 579	80x80x60	11,12,13,21,22,23,31,32,33	fully nailed	1,97	2,07
89 580	80x80x80	11,12,13,14,21,22,23,24,31,32,33,34	fully nailed	2,63	2,77
89 581	80x80x100	11,12,13,14,15,21,22,23,24,25,31,32,33,34,35	fully nailed	3,29	3,46
89 582	100x100x60	11,12,13,21,22,23,31,32,33,41,42,43	fully nailed	2,04	2,07
89 583	100x100x80	11,12,13,14,21,22,23,24,31,32,33,34,41,42,43,44	fully nailed	2,72	2,77
89 584	100x100x100	11,12,13,14,15,21,22,23,24,25,31,32,33,34,35,41,42,43,44,45	fully nailed	3,40	3,46
89 585	40x40x100	11,12,13,14,15	fully nailed	2,71	2,21
89 586	40x40x140	11,12,13,14,15,16,17	fully nailed	3,80	3,10
89 587	40x40x200	11,12,13,14,15,16,17,18,19,20	fully nailed	5,43	4,43
89 588	60x60x40	11,12,21,22	fully nailed	1,24	1,38
89 589	60x60x60	11,12,13,21,22,23	fully nailed	1,86	2,07
89 600	60x40x60	11,12,13,21,22,23	fully nailed	1,63	2,07
89 601	80x60x60	11,12,13,21,22,23,31,32,33	fully nailed	1,86	2,07
89 602	100x60x60	11,12,13,21,22,23,31,32,33,41,42,43	fully nailed	1,86	2,07

Table B.5: Forces $F_{2,3}$, 2 angle brackets / connection

Bracket number	Bracket type	Nail number n_V	Nail number n_H	$F_{2,3,Rk}$ [kN]
				Timber
89 521	50x50x35	1,2	6,7,9,10	2,63
89 525	90x90x40	1,2,4,5,6,7	11,12,14,15,19,20	4,73
89 530	160x40x40	1,2,3,4,6,7,8,9,10,11	15,16,18,19	5,76
89 533	90x35x40	1,2,3,5,6	8,9,11,12	4,33
89 560	90x48x48	1,2,4,5,6,7	10,11,13,14	5,23
89 561	90x48x76	1,2,3,6,7,8,9,10,11,12	16,17,20,21	6,73
89 562	90x48x116	1,2,3,4,5,8,9,10,11,12,13,15,16,17,18	22,23,24,25,29,30,31	13,6
89 571	40x40x40	11,12	fully nailed	3,25
89 572	50x50x40	11,12	fully nailed	3,25
89 573	60x60x40	11,12,21,22	fully nailed	4,40
89 574	60x60x50	11,12,13,21,22	fully nailed	6,71
89 575	60x60x60	11,12,13,21,22,23	fully nailed	8,08
89 576	40x40x60	11,12,13	fully nailed	6,09
89 577	60x60x80	11,12,13,14,21,22,23,24	fully nailed	12,6
89 578	60x60x100	11,12,13,14,15,21,22,23,24,25	fully nailed	18,1
89 579	80x80x60	11,12,13,21,22,23,31,32,33	fully nailed	10,1
89 580	80x80x80	11,12,13,14,21,22,23,24,31,32,33,34	fully nailed	15,5
89 581	80x80x100	11,12,13,14,15,21,22,23,24,25,31,32,33,34,35	fully nailed	21,9
89 582	100x100x60	11,12,13,21,22,23,31,32,33,41,42,43	fully nailed	12,2
89 583	100x100x80	11,12,13,14,21,22,23,24,31,32,33,34,41,42,43,44	fully nailed	18,5
89 584	100x100x100	11,12,13,14,15,21,22,23,24,25,31,32,33,34,35,41,42,43,44,45	fully nailed	30,4
89 585	40x40x100	11,12,13,14,15	fully nailed	20,8
89 586	40x40x140	11,12,13,14,15,16,17	fully nailed	21,1
89 587	40x40x200	11,12,13,14,15,16,17,18,19,20	fully nailed	32,3
89 588	60x60x40	11,12,21,22	fully nailed	4,37
89 589	60x60x60	11,12,13,21,22,23	fully nailed	8,03
89 600	60x40x60	11,12,13,21,22,23	fully nailed	7,33
89 601	80x60x60	11,12,13,21,22,23,31,32,33	fully nailed	9,23
89 602	100x60x60	11,12,13,21,22,23,31,32,33,41,42,43	fully nailed	10,8

Table B.6: Forces $F_{2,3}$, 1 angle bracket / connection

Bracket number	Bracket type	Nail number n_V	Nail number n_H	$F_{2,3,Rk}$ [kN]
				Timber
89 521	50x50x35	1,2	6,7,9,10	1,31
89 525	90x90x40	1,2,4,5,6,7	11,12,14,15,19,20	2,37
89 530	160x40x40	1,2,3,4,6,7,8,9,10,11	15,16,18,19	2,88
89 533	90x35x40	1,2,3,5,6	8,9,11,12	2,16
89 560	90x48x48	1,2,4,5,6,7	10,11,13,14	2,62
89 561	90x48x76	1,2,3,6,7,8,9,10,11,12	16,17,20,21	3,36
89 562	90x48x116	1,2,3,4,5,8,9,10,11,12,13,15,16,17,18	22,23,24,25,29,30,31	6,80
89 571	40x40x40	11,12	fully nailed	1,62
89 572	50x50x40	11,12	fully nailed	1,62
89 573	60x60x40	11,12,21,22	fully nailed	2,20
89 574	60x60x50	11,12,13,21,22	fully nailed	3,35
89 575	60x60x60	11,12,13,21,22,23	fully nailed	4,04
89 576	40x40x60	11,12,13	fully nailed	3,05
89 577	60x60x80	11,12,13,14,21,22,23,24	fully nailed	6,32
89 578	60x60x100	11,12,13,14,15,21,22,23,24,25	fully nailed	9,05
89 579	80x80x60	11,12,13,21,22,23,31,32,33	fully nailed	5,06
89 580	80x80x80	11,12,13,14,21,22,23,24,31,32,33,34	fully nailed	7,74
89 581	80x80x100	11,12,13,14,15,21,22,23,24,25,31,32,33,34,35	fully nailed	10,9
89 582	100x100x60	11,12,13,21,22,23,31,32,33,41,42,43	fully nailed	6,12
89 583	100x100x80	11,12,13,14,21,22,23,24,31,32,33,34,41,42,43,44	fully nailed	9,27
89 584	100x100x100	11,12,13,14,15,21,22,23,24,25,31,32,33,34,35,41,42,43,44,45	fully nailed	15,2
89 585	40x40x100	11,12,13,14,15	fully nailed	10,4
89 586	40x40x140	11,12,13,14,15,16,17	fully nailed	10,6
89 587	40x40x200	11,12,13,14,15,16,17,18,19,20	fully nailed	16,1
89 588	60x60x40	11,12,21,22	fully nailed	2,19
89 589	60x60x60	11,12,13,21,22,23	fully nailed	4,01
89 600	60x40x60	11,12,13,21,22,23	fully nailed	3,67
89 601	80x60x60	11,12,13,21,22,23,31,32,33	fully nailed	4,62
89 602	100x60x60	11,12,13,21,22,23,31,32,33,41,42,43	fully nailed	5,41

Table B.7: Basic Forces $F_{4,5}$, 2 angle brackets / connection

Bracket number	Bracket type	Nail number n_V	Nail number n_H	$F_{4,5,RK}$ [kN]	
				Timber	Steel
89 521	50x50x35	1,2	6,7,9,10	7,40	2,12
89 525	90x90x40	1,2,4,5,6,7	11,12,14,15,19,20	6,00	3,76
89 530	160x40x40	1,2,3,4,6,7,8,9,10,11	15,16,18,19	6,31	3,14
89 532	120x35x40	1,2,3,4,5,6,7,8,9	bolt	4,96	3,76
89 533	90x35x40	1,2,3,5,6	8,9,11,12	3,76	3,41
89 560	90x48x48	1,2,4,5,6,7	10,11,13,14	4,33	5,31
89 561	90x48x76	1,2,3,6,7,8,9,10,11,12	16,17,20,21	7,26	8,49
89 562	90x48x116	1,2,3,4,5,8,9,10,11,12,13,15,16,17,18	22,23,24,25,29,30,31	11,39	13,07
89 571	40x40x40	11,12	fully nailed	6,52	1,89
89 572	50x50x40	11,12	fully nailed	6,52	1,89
89 573	60x60x40	11,12,21,22	fully nailed	5,12	2,17
89 574	60x60x50	11,12,13,21,22	fully nailed	6,87	3,12
89 575	60x60x60	11,12,13,21,22,23	fully nailed	7,69	3,26
89 576	40x40x60	11,12,13	fully nailed	8,93	3,72
89 577	60x60x80	11,12,13,14,21,22,23,24	fully nailed	9,86	5,43
89 578	60x60x100	11,12,13,14,15,21,22,23,24,25	fully nailed	12,33	6,79
89 579	80x80x60	11,12,13,21,22,23,31,32,33	fully nailed	8,09	4,31
89 580	80x80x80	11,12,13,14,21,22,23,24,31,32,33,34	fully nailed	10,78	5,75
89 581	80x80x100	11,12,13,14,15,21,22,23,24,25,31,32,33,34,35	fully nailed	13,48	7,19
89 582	100x100x60	11,12,13,21,22,23,31,32,33,41,42,43	fully nailed	8,70	4,31
89 583	100x100x80	11,12,13,14,21,22,23,24,31,32,33,34,41,42,43,44	fully nailed	11,60	5,74
89 584	100x100x100	11,12,13,14,15,21,22,23,24,25,31,32,33,34,35,41,42,43,44,45	fully nailed	14,53	7,55
89 585	40x40x100	11,12,13,14,15	fully nailed	16,29	4,73
89 586	40x40x140	11,12,13,14,15,16,17	fully nailed	22,80	6,62
89 587	40x40x200	11,12,13,14,15,16,17,18,19,20	fully nailed	32,57	9,45
89 588	60x60x40	11,12,21,22	fully nailed	4,93	2,71
89 589	60x60x60	11,12,13,21,22,23	fully nailed	7,40	4,07
89 600	60x40x60	11,12,13,21,22,23	fully nailed	6,92	4,68
89 601	80x60x60	11,12,13,21,22,23,31,32,33	fully nailed	7,79	4,38
89 602	100x60x60	11,12,13,21,22,23,31,32,33,41,42,43	fully nailed	7,84	4,51

Definitions of forces, their directions and eccentricity

Forces - Beam to beam connection

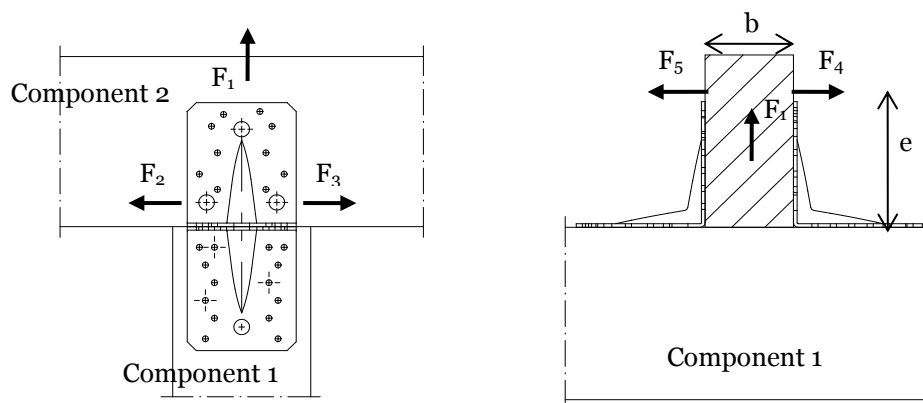

Fastener specification

Holes are marked with numbers referring to the nailing pattern in Annex A.

Double angle brackets per connection

The angle brackets must be placed at each side opposite to each other, symmetrically to the component axis.

Acting forces

- F_1 Lifting force acting along the central axis of the joint.
- F_2 and F_3 Lateral force acting in the joint between the component 2 and component 1 in the component 2 direction
- F_4 and F_5 Lateral force acting in the component 1 direction along the central axis of the joint. If the load is applied with an eccentricity e , a design for combined loading is required.

Single angle bracket per connection

Acting forces

- F_1 Lifting force acting in the central axis of the angle bracket. The component 2 shall be prevented from rotation. If the component 2 is prevented from rotation the load-carrying capacity will be half of a connection with double angle brackets.
- F_2 and F_3 Lateral force acting in the joint between the component 2 and the component 1 in the component 2 direction. The component 2 shall be prevented from rotation. If the component 2 is prevented from rotation the load-carrying capacity will be half of a connection with double angle brackets.
- F_4 and F_5 Lateral force acting in the component 1 direction in the height of the top edge of component 2. F_4 is the lateral force towards the angle bracket; F_5 is the lateral force away from the angle bracket. Only the characteristic load-carrying capacities for angle brackets with ribs are given.

Wane

Wane is not allowed, the timber has to be sharp-edged in the area of the angle brackets.

Timber splitting

For the lifting force F_1 it must be checked in accordance with Eurocode 5 or a similar national Timber Code that splitting will not occur.

Connection to concrete or steel with a bolt or metal anchor

The tensile load $F_{B,Ed}$ for the design of a bolt or metal anchor is calculated as:

$$F_{B,Ed} = F_{1,d} \cdot \left(1 + \frac{e_B}{z} \right)$$

Where:

- e_B Eccentricity of the bolt with regard to the force F_1
- z Distance between the bolt and the end of the horizontal flap of the angle bracket

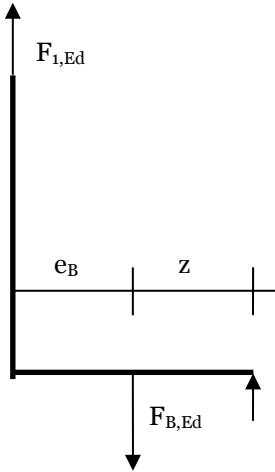

Combined forces

If the forces F_1 and F_2/F_3 or F_4/F_5 act at the same time, the following inequality shall be fulfilled:

$$\left(\frac{F_{1,d}}{F_{Rd,1}} \right)^2 + \left(\frac{F_{2,d}}{F_{Rd,2}} \right)^2 + \left(\frac{F_{3,d}}{F_{Rd,3}} \right)^2 + \left(\frac{F_{4,d}}{F_{Rd,4}} \right)^2 + \left(\frac{F_{5,d}}{F_{Rd,5}} \right)^2 \leq 1$$

The forces F_2 and F_3 or F_4 and F_5 are forces with opposite direction. Therefore only one force F_2 or F_3 , and F_4 or F_5 , respectively, is able to act simultaneously with F_1 , while the other shall be set to zero.

If the load F_4/F_5 is applied with an eccentricity e , a design for combined loading **for connections with double angle brackets** is required. Here, an additional force ΔF_1 has to be added to the existing force F_1 .

$$\Delta F_{1,d} = F_{4,d} / F_{5,d} \cdot \frac{e}{B}$$

B is the width of component 2.

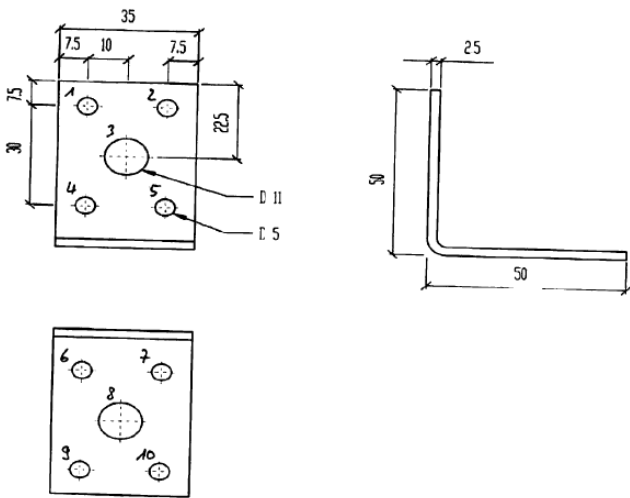

Figure B. 1 Dimensions of Angle Bracket 89 521

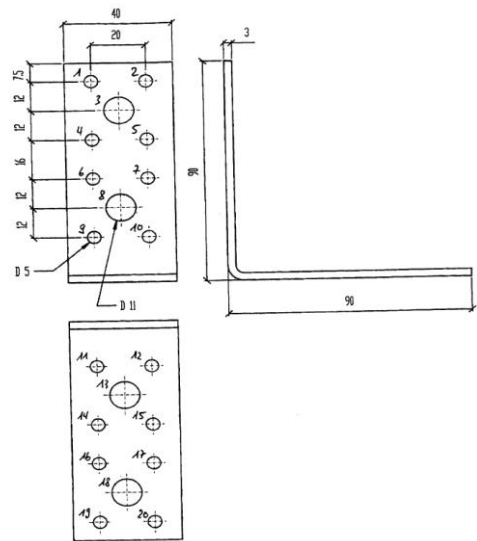

Figure B. 2 Dimensions of Angle Bracket 89 525

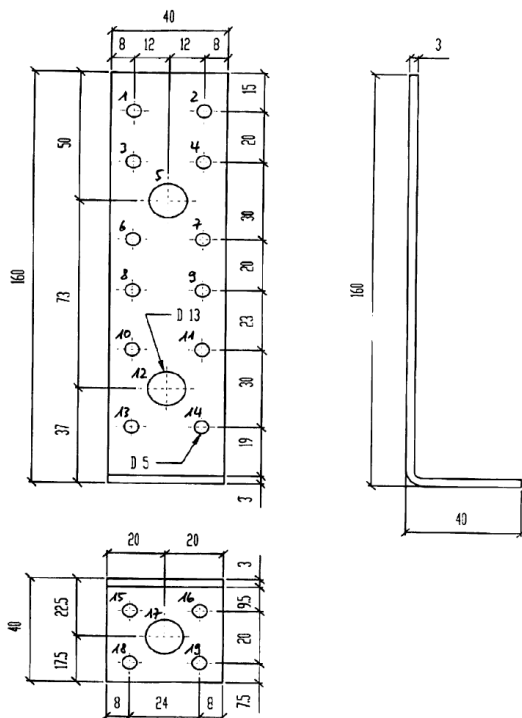

Figure B. 3 Dimensions of Angle Bracket 89 530

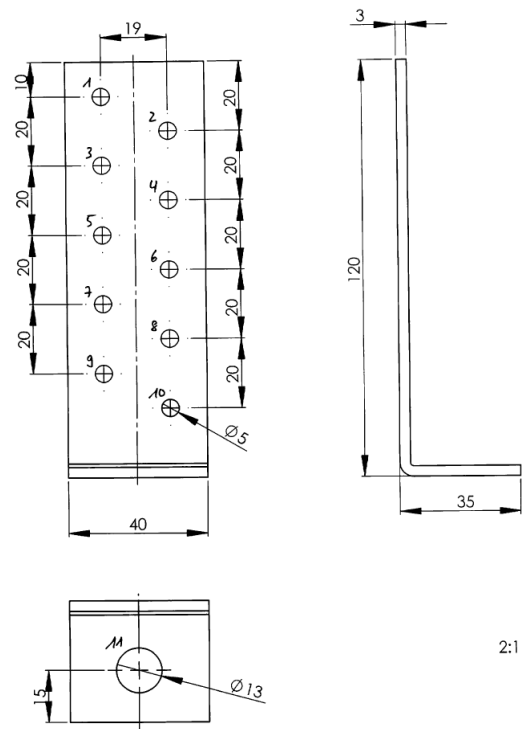

Figure B. 4 Dimensions of Angle Bracket 89 532

2:1

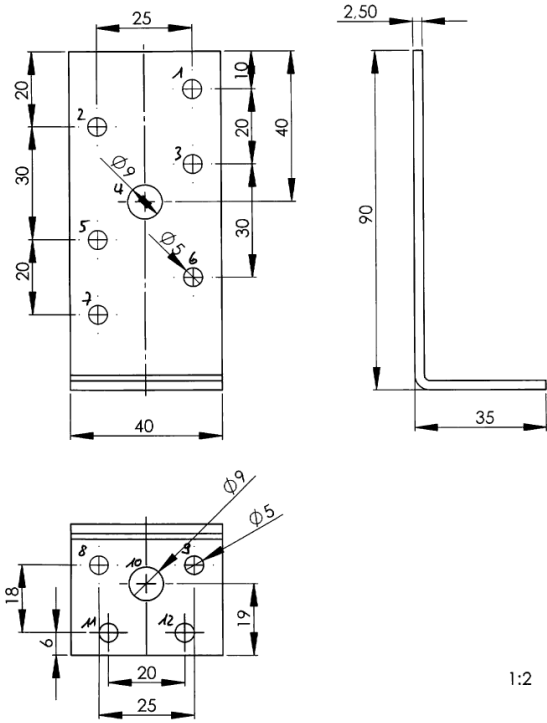

Figure B. 5 Dimensions of Angle Bracket 89 533

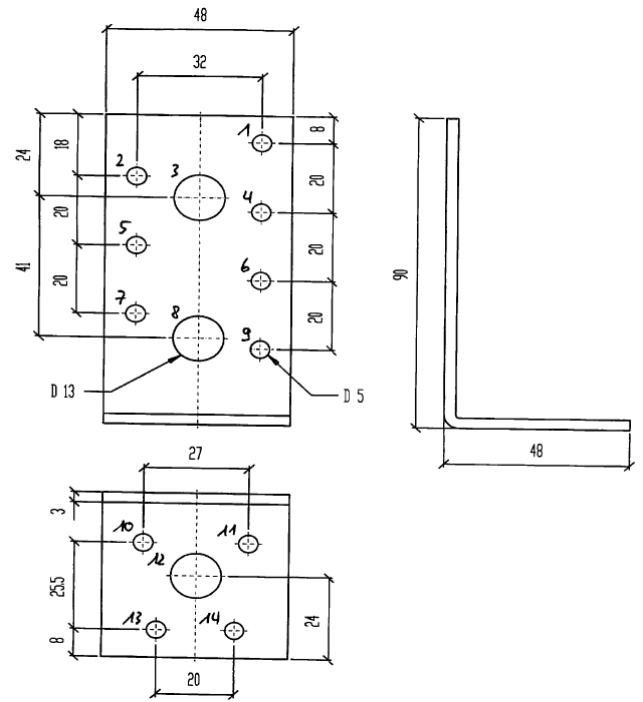

Figure B. 6 Dimensions of Angle Bracket 89 560

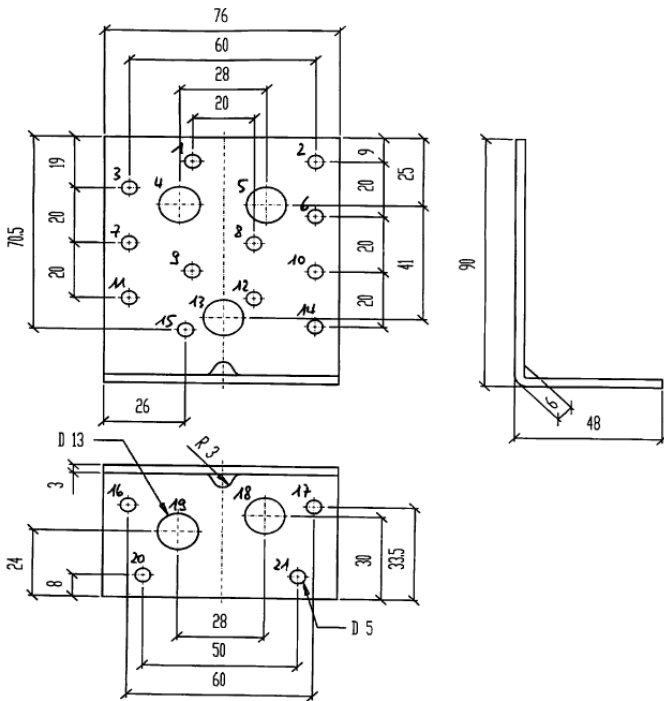

Figure B. 7 Dimensions of Angle Bracket 89 561

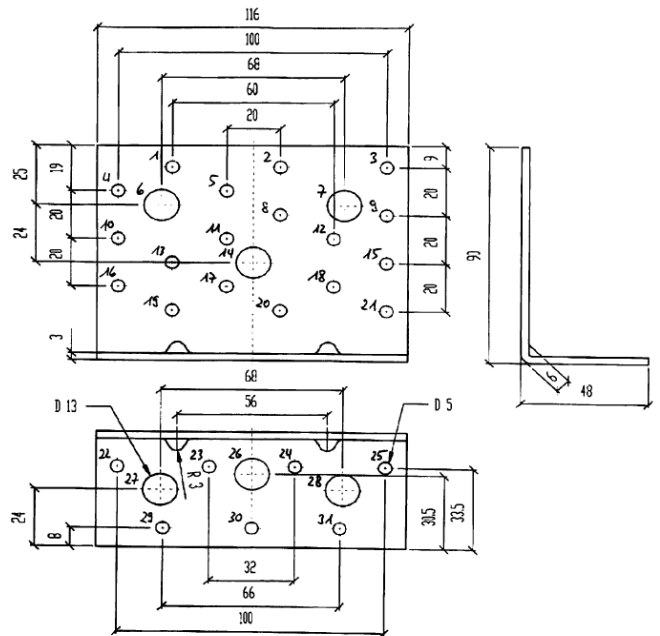

Figure B. 8 Dimensions of Angle Bracket 89 562

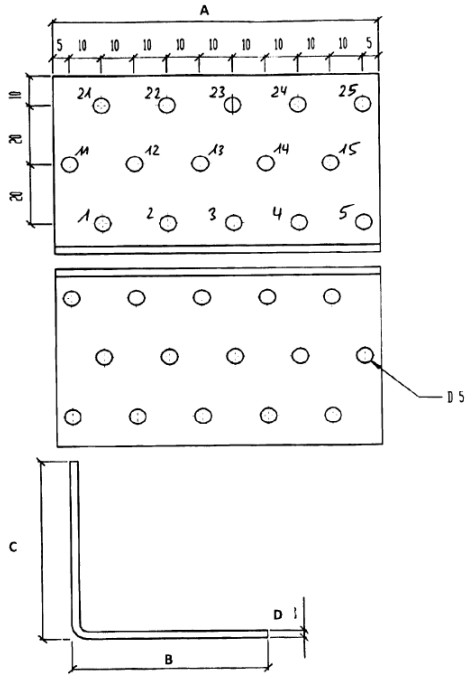

Figure B. 9 Dimensions of Angle Bracket 89 571 - 89 589

Number	B	C	A	D
89 571	40	40	40	2
89 572	50	50	40	2
89 573	60	60	40	2
89 574	60	60	50	2,5
89 575	60	60	60	2
89 576	40	40	60	2,5
89 577	60	60	80	2,5
89 578	60	60	100	2,5
89 579	80	80	60	2,5
89 580	80	80	80	2,5
89 581	80	80	100	2,5
89 582	100	100	60	2,5
89 583	100	100	80	2,5
89 584	100	100	100	2,5
89 585	40	40	100	2
89 586	40	40	140	2
89 587	40	40	200	2
89 588	60	60	40	2,5
89 589	60	60	60	2,5

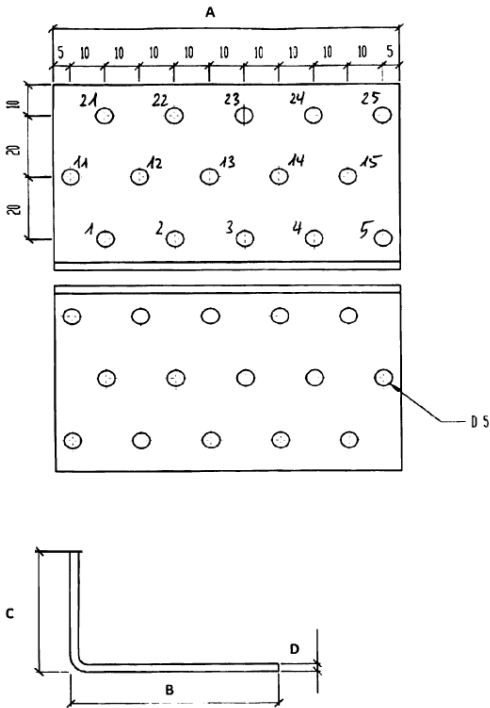

Figure B. 10 Dimensions of Angle Bracket 89 600 - 89 602

Number	B	C	A	D
89 600	40	60	60	2,5
89 601	60	80	60	2,5
89 602	60	100	60	2,5

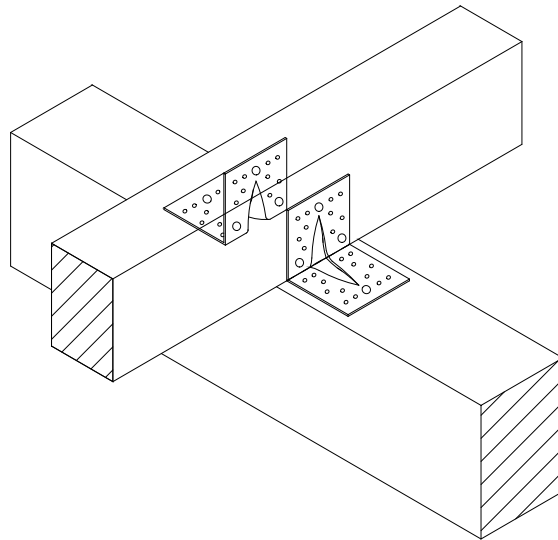

Figure B. 111 Typical installation